



Quality Tools for Smart Cleaning



**RESERVEONDERDELEN 2024**

# PRODUCTASSORTIMENT

## ZUIVER WATER SYSTEEM



### Zuiver-water filters

HydroPower® DI Filter .....	3
HydroPower® RO M, RO L Filter .....	4
HydroPower® RO M, RO L Filter .....	5
HiFlo RO60C, RO60S, RO30G, RO30C Filter .....	6
HydroPower® RO XXL aanhanger .....	10

### Watergeleidende steelsystemen

nLITE® .....	12
Snelkoppeling en hoes .....	13
nLite® Connect .....	14

## KLASSIEKE GLASREINIGING



Telescoopstelen .....	16
Wissers .....	16
Schrapers .....	17

## RAAM BINNENREINIGING



STINGRAY systeem .....	18
------------------------	----

## ONDERHOUDSREINIGING



erGO! systeem .....	19
Gereedschapshouder .....	19
Dubbele rolemmers .....	19
Shop .....	19

# ZUIVER WATER FILTER HYDRO POWER® ULTRA + DI



Quality Tools for Smart Cleaning

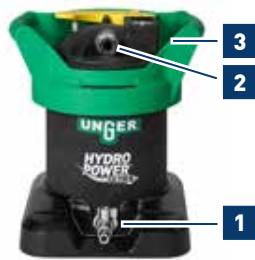

HydroPower DI  
(2015-2019)



Art. Nr.	VPE	€/stuk
21065	1 (incl. afdichtring)	



Art. Nr.	VPE	€/stuk
23239	1 kit (5x)	



Art. Nr.	VPE	€/stuk
21064	1 (incl. afdichtring)	



Art. Nr.	Info	VPE	€/stuk
DIUTC	compleet, met TDS-meter	1	
21072	zonder TDS-meter	1	



Art. Nr.	Info	VPE	€/stuk
UHP5R	5x afdichtingsringen, onderhouzalf	1 kit	



Art. Nr.	Info	VPE	€/stuk
22269	Tank DIUH1 leeg	1	
22271	Tank DIUH2/3 leeg	1	



Art. Nr.	VPE	€/stuk
18330	1	



Art. Nr.	Info	VPE	€/stuk
18839	Vermindert de waterstroom	1	



Art. Nr.	VPE	€/stuk
18776	1	



Art. Nr.	VPE	€/stuk
18775	1	



Art. Nr.	Info	VPE	€/stuk
DITCP	compleet, met TDS-meter	1	
18549	zonder TDS-meter	1	



Art. Nr.	Info	VPE	€/stuk
DISKT	5x afdichtingsringen, onderhouzalf	1 kit	
19021	1x afdichtingsring	1	

## HYDRO POWER ULTRA + HYDRO POWER DI

	Art. Nr.	Product	Info	VPE	€/stuk	HP Ultra	HP DI
	21151	TDS METER	Inclusief batterijen: 2x LR44	1		✓	✓
	19038	SET WIELEN	4 wielen	1 kit		✓	✓
	20586	RESERVEWIEL	1 kit	1		✓	✓
	18503	TRANSPORTSTOP ROOD		1			✓
	23234	TRANSPORTSTOP GEEL		1		✓	✓
	22601	TRANSPORTWAGEN HYDRO POWER ULTRA		1		✓	
	18919	BEVEILIGINGSCLIP VOOR TRANSPORTWAGEN		1		✓	✓

Ø 20mm

# ZUIVER WATER FILTERS HYDRO POWER® RO S



RO S (RO20C)



**1** **HydroPower® RO S**  
**COMBIFILTER CHLOOR/SEDIMENTEN**

Art. Nr.	VPE	€/stuk
ROCA2	1	



**2** **HydroPower® RO S**  
**MEMBRANE**

Art. Nr.	Product	VPE	€/stuk
ROME2	Membrane	1	
22355	Afdichtring	1	

Plaats het **RO-membraan (ROME2)** met de goede kant naar boven:

- De pijl moet naar boven wijzen.
- De rubberen afdichting moet altijd boven worden geplaatst!



**3** **HydroPower® RO S**  
**HARS PATROON**

Art. Nr.	VPE	€/stuk
RORE2	1	

Plaats het **DI harsfilter (RORE2)** met de juiste kant naar boven:

Plaats het blauwe filterelement naar boven.

**Onjuiste plaatsing van het filter kan het toestel beschadigen!**



**1**  
**3** **HydroPower® RO S**  
**FILTER GEVAL COMPLEET**

Art. Nr.	VPE	€/stuk
22345	1	



**1+2** **HydroPower® RO S**  
**FILTERSLEUTEL**

Art. Nr.	VPE	€/stuk
22897	1	



**1** **HydroPower® RO S**  
**ZUIGBUIS VOOR MEMBRAAN-VERZORGINGSMIDDEL**

Art. Nr.	VPE	€/stuk
22348	1	



**4** **HydroPower® RO S**  
**WATERINGANG VERCHROOMD MESSING MED WATERKRAAN**

Art. Nr.	VPE	€/stuk
22459	1 (incl. afdichtring)	



**4** **HydroPower® RO S**  
**WATER UIT AANSLUITING**

Art. Nr.	VPE	€/stuk
ROWOT	1	



**4** **HydroPower® RO**  
**DRUKREGELAAR**  
Verlaagt de watertoevoerdruk tot 4 bar

Art. Nr.	VPE	€/stuk
18782	1	



**HydroPower® RO S**  
**BESCHERMEDE CLIPS VOOR KAR**

Art. Nr.	VPE	€/stuk
18919	1	



**HydroPower® DI/RO**  
**RESERVEWIEL KUNSTSTOF**

Art. Nr.	Info	VPE	€/stuk
20586	1x wiel + beschermkap	1	
20326	Kit beschermkap + sluitring	1 kit	



**RO-MEMBRAAN-VERZORGINGSMIDDEL**

Art. Nr.	Content	VPE	€/stuk
15436	1 l	1	



**HydroPower® RO S**  
**STROOMKABEL MET AARDLEKSCHAKELAAR**

Art. Nr.	VPE	€/stuk
23346	1	



# ZUIVER WATER FILTERS HYDRO POWER® RO M / RO L



RO M (RO35C)

RO L (RO40C)



## 1 HydroPower® RO VOORFILTERPATRON „CHLOOR“

Art. Nr.	VPE	€/stuk
ROCAR	1µ	1

Na vervanging van het voorfilter (ROCAR) moet de waarde op het display gereset worden.



## 2+3 HydroPower® RO MEMBRANE

Art. Nr.	VPE	€/stuk
ROMEM	RO40C bezit 2 membranen vervang altijd samen!	1
20967	Afdichtring	1

De 2 membranen (ROMEM) hebben een opschrift, dat de stroomrichting aangeeft.

- De pijl moet naar boven wijzen.
- De rubberen afdichtring moet altijd boven worden geplaatst!

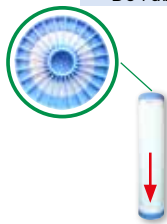

## 4 HydroPower® RO HARS PATROON

Art. Nr.	VPE	€/stuk
RORES		1

Plaats het DI harsfilter (RORES) met de goede kant naar boven:

- Blauw deksel met papieren filterinzet naar boven
- Pijl op de behuizing wijst naar beneden

Het verkeerd plaatsen van het filter kan het apparaat beschadigen! De afsluitdop moet goed op zijn plaats zitten!

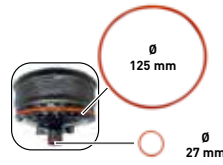

## HydroPower® RO AFDICHTINGSSET VOOR SLUITING 1+4 (2 ST.)

Art. Nr.	VPE	€/stuk
ROOR1	voor sluiting 1 (voorfilter)	1
ROOR4	voor sluiting 4 (hars)	1

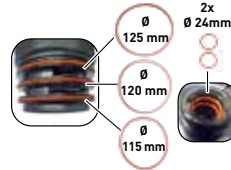

## HydroPower® RO AFDICHTINGSSET VOOR SLUITING 2+3 (5 ST.)

Art. Nr.	VPE	€/stuk
ROOR2	voor sluiting 2 (membraan 1)	1
ROOR3	voor sluiting 3 (membraan 2)	1



## HydroPower® RO AFSLUITDOP

Art. Nr.	VPE	€/stuk
ROOR5	voor tank 4 (hars)	1



## HydroPower® RO SLUITING

Art. Nr.	VPE	€/stuk
ROLD1	voor tank 1 (voorfilter)	1
ROLD2	voor tank 2 (membraan 1)	1
ROLD3	voor tank 3 (membraan 2)	1
ROLD4	voor tank 4 (hars)	1



## HydroPower® RO WATER IN AANSLUITING

Art. Nr.	VPE	€/stuk
ROWIN		1



## HydroPower® RO WATER UIT AANSLUITING

Art. Nr.	VPE	€/stuk
ROWOT		1



## HydroPower® RO DRUKREGELAAR Verlaagt de watertoevoerdruk tot 4 bar

Art. Nr.	VPE	€/stuk
18782		1



## HydroPower® RO DRUKMETER/DISPLAY-ASSEMBLAGE

Art. Nr.	VPE	€/stuk
21855	RO35C	1
20323	RO40C	1



## HydroPower® RO CONCENTRAAT SLANG

Art. Nr.	VPE	€/stuk
ROCHO		1



## HydroPower® DI/RO RESERVEWIEL KUNSTSTOF

Art. Nr.	Info	VPE	€/stuk
20586	1x wiel + beschermkap	1	
20326	Kit beschermkap + sluitring	1 kit	



## RO-MEMBRAAN-VERZORGINGSMIDDEL

Art. Nr.	Content	VPE	€/stuk
15436	1 l	1	



## HydroPower® RO S STROOMKABEL

Art. Nr.	VPE	€/stuk
19499		1

# ZUIVER WATER FILTERS

## HIFLO R060C/S, R030G/C

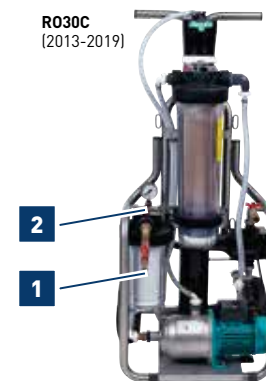
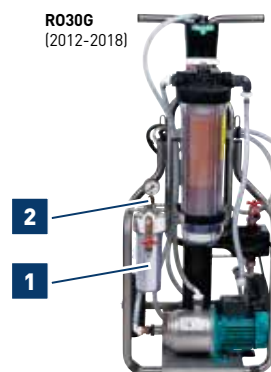
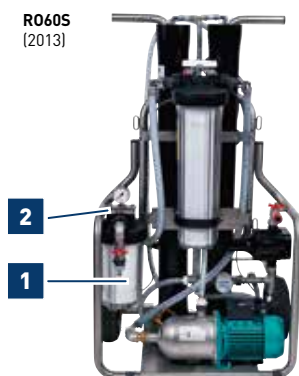
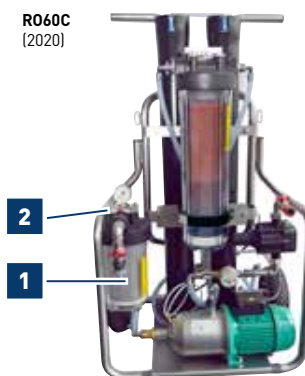

1 VOORFILTER									
	Art. Nr.	Produkt	Info	VPE	€/stuk	R060C	R060S	R030G	R030C
	17522	VOORFILTER GEVAL KLEIN	4,5" x 10"	1					✓
	22620	VOORFILTER GEVAL KLEIN	4,5" x 10"	1			✓		
	23428	VOORFILTER GEVAL KLEIN	4,5" x 10"	1		✓			
	17521	VOORFILTER PATRON (voor 17522)	4,5" x 10"	1		(✓)	✓		✓
	17509	COMBI-VOORFILTER (FIJNPARTIKEL +CHLOOR) (voor 17522)	4,5" x 10"	1		✓			✓
	17020	AFDICHTINGSRING VOOR FILTERHUIS 4,5"	4,5"	1		✓	✓		✓
	17194*	FILTERSLEUTEL 4,5" (voor 17522, 17195)	4,5"	1		✓	✓		✓
	17195	VOORFILTER GEVAL GROOT ZONDER BORING (voor voorfilter "chloor" 17919)	4,5" x 20"	1			✓		
	17919	VOORFILTER "CHLOOR" MET AFLSUITRING (voor 17195)	20"	1			✓		
	16574	VOORFILTERPATRON	2,5" x 10"	1				✓	
	17188	VOORFILTERPATRON FIJNPARTIKEL (voor 16574)	2,5" x 10"	1				✓	
	16637*	FILTERSLEUTEL 2,5"	2,5"	1				✓	

2 WATERINGANG & -UITGANG									
	Art. Nr.	Produkt	Info	VPE	€/stuk	R060C	R060S	R030G	R030C
	18775	WATERAANSLUITING	3/4"	1		✓	✓	✓	✓
	17024	STANDAARD SLANGAANSLUITING 1/2"	1/2"	1				✓	✓
	17915	STANDAARD SLANGAANSLUITING 1"	1"	1		✓	✓		
	16636	MANOMETER INGANGSDRUK		1		✓	✓	✓	✓
	17607	WATER UIT		1		✓	✓	✓	✓
	17511	WATER IN ONDERDEEL (na voorfilter)		1				✓	✓
	21826	ZUIVER WATERSTROOMMETER		1		✓	✓		



# ZUIVER WATER FILTERS



## HIFLO R060C/S, R030G/C

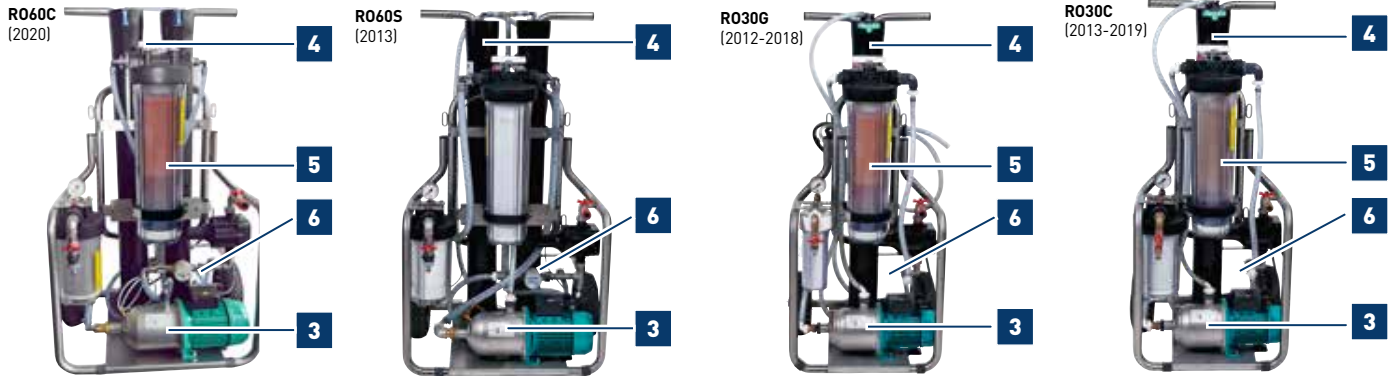







Quality Tools for Smart Cleaning



3 POMP									
	Art. Nr.	Produkt	Info	VPE	€/stuk	R060C	R060S	R030G	R030C
	17918*	HIGH PERFORMANCE-POMP R060		1		✓	✓		
	17193*	HIGH PERFORMANCE-POMP R030		1				✓	✓
	21818	POMPBESTURING		1		✓	✓	✓	✓

4 MEMBRANEN									
	Art. Nr.	Produkt	Info	VPE	€/stuk	R060C	R060S	R030G	R030C
	17189	MEMBRANE	4" x 40"	1		✓	✓	✓	✓
	17190	DRUKPIJP (voor 17189)	4" x 40"	1		✓	✓	✓	✓
	17191	MANOMETER BEDRIJFSDRUK		1		✓	✓	✓	✓













5 HARS NAFILTER									
	Art. Nr.	Produkt	Info	VPE	€/stuk	R060C	R060S	R030G	R030C
	17196	HARSFILTERBEHUIZING (MET BORING)	4,5" x 20"	1		✓			
	17020	AFDICHTINGSRING VOOR HARSFILTERBEHUIZING 4,5"	4,5"	1		✓		✓	✓
	17197	HARS CARTRIDGE 20", LEEG	20"	1		✓		✓	✓
	17201	HARS CARTRIDGE 20", GEVULD	20"	1		✓		✓	✓
	17079	AFDICHTINGSRING (voor 17197, 17201)		1		✓		✓	✓
	17194*	FILTERSLEUTEL (HARS)	4,5"	1		✓		✓	✓

\*Kleur kan variëren

# ZUIVER WATER FILTERS

## HIFLO R060C/S, R030G/C

6 SLANGEN									
Art. Nr.	Produkt	Info	VPE	€/stuk	R060C	R060S	R030G	R030C	
	18074	AFDICHRING SLANGVERBINDING 3/4"	3/4"	1		✓	✓	✓	✓
	18045	AFDICHRING SLANGVERBINDING 1"	1"	1		✓	✓		
	18339	SLANG KOPPELINGEN rechtdoor	3/4"	1		✓	✓	✓	✓
	18340	SLANG KOPPELINGEN hoekig	3/4"	1		✓	✓	✓	✓
	17920	CAPILLAIRE BUIS Membranen bij de pomp		1		✓	✓	✓	✓
	17921	CAPILLAIRE BUIS Concentraat		1		✓	✓	✓	✓

TOEBEHOREN									
Art. Nr.	Produkt	Info	VPE	€/stuk	R060C	R060S	R030G	R030C	
	15436	MEMBRAAN-VERZORGINGSMIDDEL	4" x 40"	1		✓	✓	✓	✓
	17605	ZUIGBUIS VOOR MEMBRAAN-VERZORGINGSMIDDEL	4" x 40"	1			✓		
	22886	ZUIGBUIS VOOR MEMBRAAN-VERZORGINGSMIDDEL		1		✓	✓		✓
	ROTDS	TDS-METER		1		✓	✓	✓	✓
	16576	TDS-MONITOR		1		✓	✓	✓	✓
	18322	SENSORKOPPELING		1		✓	✓	✓	✓
	18782	DRUKREGELAAR (Verlaagt de watertoevoerdruk tot 4 bar)		1		✓	✓	✓	✓
	18164	DUBBEL SCHROEFDRAAD 3/4"	3/4"	1		✓		✓	✓
	20669	DUBBEL SCHROEFDRAAD 3/4" - 1"	3/4" - 1"	1		✓	✓	✓	✓
	18239	DUBBEL SCHROEFDRAAD 1"	1"	1			✓		
	15961	RESERVEWIEL KUNSTSTOF		1		✓	✓	✓	✓
	17512	CHLOOR TESTSTRIPS		1		✓	✓		✓
	15731	EINDSTOPPEN VOOR STEEKWAGENGREEP		1		✓	✓	✓	✓
	16749	TRANSPORTPLUG 3/4"	3/4"	1				✓	✓
	18238	TRANSPORTPLUG 1"	1"	1		✓	✓		
	19499	STROOMKABEL		1		✓	✓	✓	✓

Ø 30mm



**UNGER**

Quality Tools for Smart Cleaning

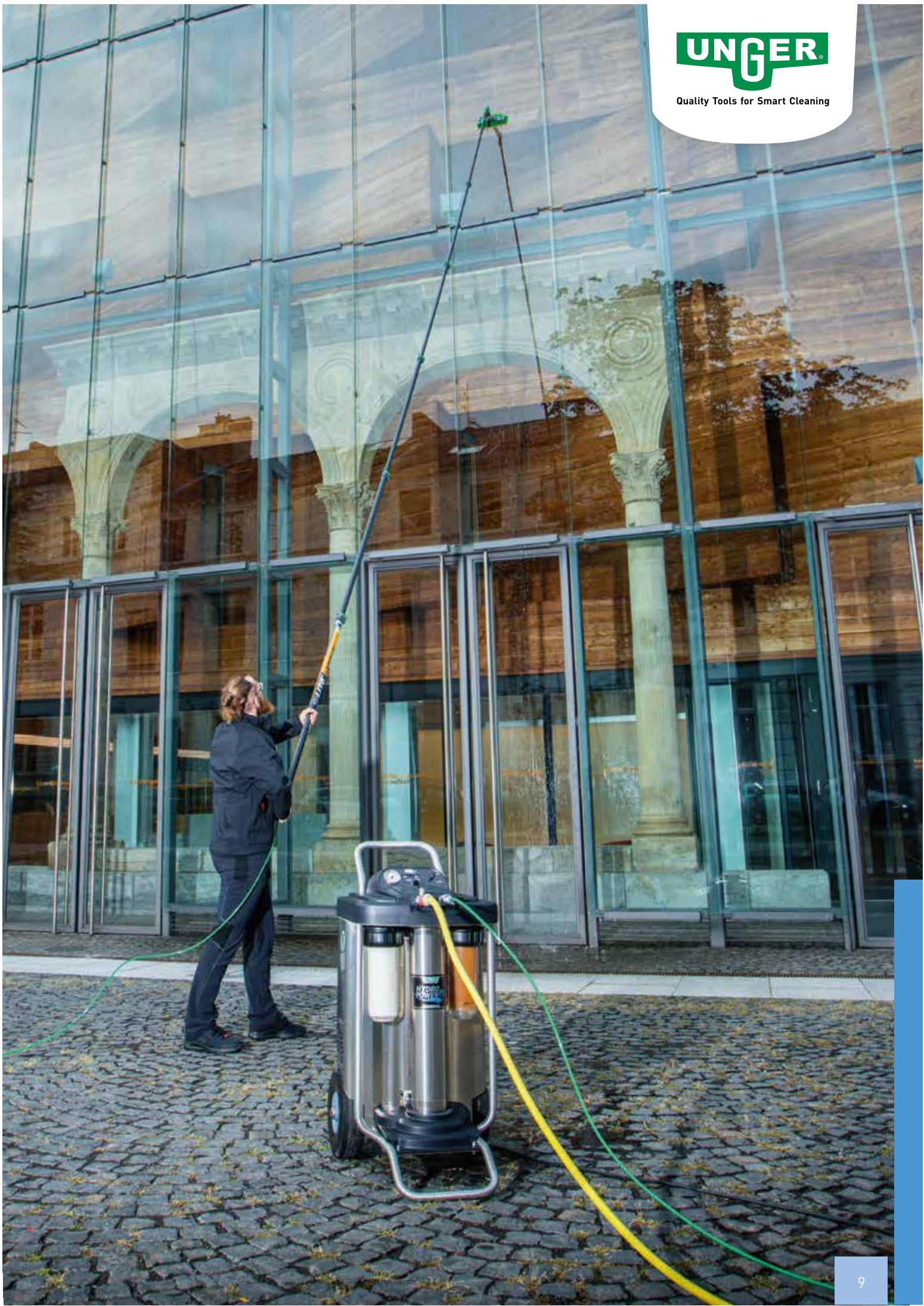



# ZUIVER WATER FILTERS HYDRO POWER® RO XXL

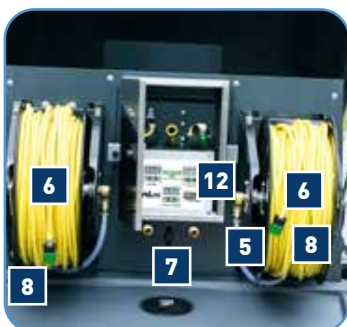

# ZUIVER WATER FILTERS HYDRO POWER® RO XXL



Quality Tools for Smart Cleaning

Art Nr.	Produkt	Info	VPE	€/stuk
18998	1 VERGRENDELBOUW VOOR DEKSEL		1	
18999	2 STEUNPOOT		1	
19063	3 DIAPHRAGM POMP SHURFLO		1	
19064	4 PLASTIC ZEEF		1	
19065	5 SNELKOPPELING PLASTIC		1	
19066	6 SLANGHASPEL ROESTVRIJ STAAL (ZONDER SLANG)	links	1	
19067	6 SLANGHASPEL ROESTVRIJ STAAL (ZONDER SLANG)	rechts	1	
19068	7 SLANG TRANSPARENT, VERSTERKT		1	
19070	8 SLANG 100M, GEEL (8/12MM)		1	
19076	10 MEMBRAAN		1	
19077	11 DRUKBUIS VOOR MEMBRAAN		1	
19078	12 AFSTANDSBEDIENING	Channel 1-15 <b>LET OP! Geelieve het kanaal te specificeren (zie sticker)</b>	1	
19082	13 WATERTANKDOP		1	
19080	14 CARBON VOORFILTER		1	
19081	15 VOORFILTER CASE KPL.		1	
19099	16 AGM BATTERIJ, FULLRIVER, BLAUW	12V DC, 210A	1	
19075	9 BATTERIJ OPLADER VOOR AGM BATTERIJ, FULLRIVER, BLAUW	3A, 230 V, 12 VDC 30A	1	
21634	16 GEL BATTERIJ, EXIDE ES 2400, ZWART	12V DC, 210A	1	
21633	9 BATTERIJ OPLADER VOOR GEL BATTERIJ, EXIDE ES 2400, ZWART	3A, 230 V, 12 VDC 30A	1	
19647	PLUG-IN KNIKOPPELING KLEIN/GROOT		1	
19074	SWIVEL MALE T-KOPPELING		1	
19071	SCHROEFKOPPELING VOOR SLANG		1	
19644	EQUAL ELBOW SNELKOPPELING		1	
17421	WATERAANSLUITING, MANNELIJK		1	
19069	SLANG ZWART		1	
18270	SLANGBESCHERMER		1	
15436	RO-MEMBRAAN-VERZORGINGSMIDDEL		1	
18845	BESCHERMING COVER		1	

# WATERGELEIDENDE STELEN

## nLITE® TELESCOOP STELEN



### Elementen



### nLITE® Carbon Composite STEELELEMENTEN

Steel	Maat	Element	Elem. 1 - Ø 22mm		Elem. 2 - Ø 25mm		Elem. 3 - Ø 28mm		Elem. 4 - Ø 31mm		Elem. 5 - Ø 34mm		Elem. 6 - Ø 37mm	
			Art. Nr.	€/stuk	Art. Nr.	€/stuk	Art. Nr.	€/stuk	Art. Nr.	€/stuk	Art. Nr.	€/stuk	Art. Nr.	€/stuk
CC16T	1,60 m	2	22787		22786									
CC32T	3,20 m	2	22789		22788									
CC60T	6,00 m	4	22789		22792		22791		22790					
CC85T	8,60 m	6	22789		22792		22791		22795		22794		22793	

### nLITE® Carbon 24K STEELELEMENTEN

Steel	Maat	Element	Elem. 1 - Ø 22mm		Elem. 2 - Ø 25mm		Elem. 3 - Ø 28mm		Elem. 4 - Ø 31mm		Elem. 5 - Ø 34mm		Elem. 6 - Ø 37mm	
			Art. Nr.	€/stuk	Art. Nr.	€/stuk	Art. Nr.	€/stuk	Art. Nr.	€/stuk	Art. Nr.	€/stuk	Art. Nr.	€/stuk
CF60T	6,00 m	4	22799		22798		22797		22796					
CF86G	8,60 m	6	22799		22798		22797		22802		22801		22800	
CF33G	3,20 m	4									22804		22803	



### VERVANGEN VAN STEELELEMENTEN:

1. Verwijder de onderste schroef van de klem. Klemtape moet wellicht worden vervangen (zie hieronder).
2. Trek het steelelement voorzichtig met de klem naar boven.

**ATTENTIE:** Aan het einde van elk element bevindt zich een aanslaglint, dit mag bij het uitnemen en weer inbrengen niet beschadigd worden!



### nLITE® SmartLock KLEMMEN

Art. Nr.	Info	VPE	€/stuk
22817	Element 1; Ø 22mm	1	
22818	Element 2; Ø 25mm	1	
22819	Element 3; Ø 28mm	1	
22820	Element 4; Ø 31mm	1	
22821	Element 5; Ø 34mm	1	
22822	Element 6; Ø 37mm	1	

### SMART LOCK KLEMMEN VERVANGEN:



### nLITE® GREP

Art. Nr.	Info	VPE	€/stuk
22814	Ø 25mm [CC16T, CC32T]	1	
22815	Ø 31mm [CC60T / CF60T]	1	
22816	Ø 37mm [CC85T / CF86G / CF33G]	1	

Art. Nr.	Produkt	VPE	€/stuk
23224	Dubbelzijdige plakband 16,50m voor Smart Lock klemmen	1	
NLPCP	nLITE® beschermkap	1	
NLHCC	nLITE® uitbreidingsadapter	1	
NLHKP	nLITE® clips voor geleiding slang buitenlangs de steel	1	
23241	nLITE® borstelsocket draaibaar	1	
23242	nLITE® borstelsocket vast	1	
22137	nLITE® borstelsocket bevestigingsschroef (1x)	1	
23240	nLITE® zachte stootrand	1 kit (5)	
NLR28	nLITE® strip met sproeikop (Rinse Bar) 28cm	1	
NLR41	nLITE® strip met sproeikop (Rinse Bar) 41cm	1	
23243	nLITE® sproeiers balk 28 cm	1	
23244	nLITE® sproeiers balk 41 cm	1	

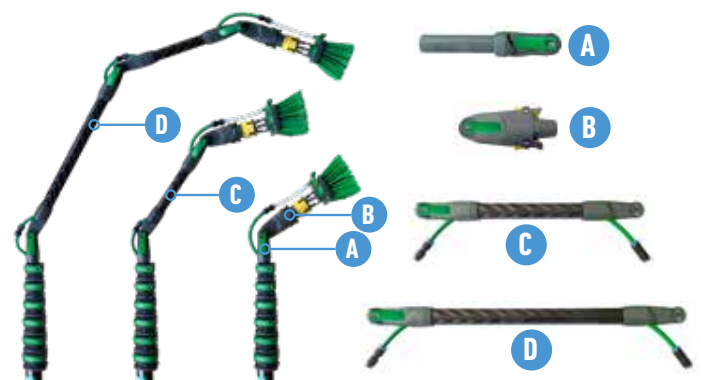

### nLITE® HOEKADAPTER ELEMENTE

Art. Nr.	Info	VPE	€/stuk
22805	Element A - steeladapter	1	
22806	Element B - borsteladapter	1	
22807	Element C - kort (incl. slang & sneltkoppeling)	1	
22808	Element D - lang (incl. slang & sneltkoppeling)	1	

# WATERGELEIDENDE STELEN

## nLITE® SNELKOPPELING, HOES

### HOES

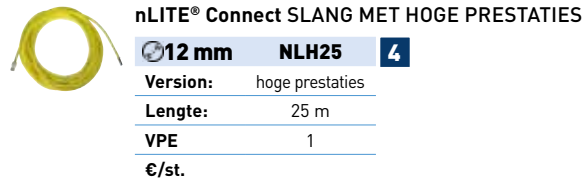
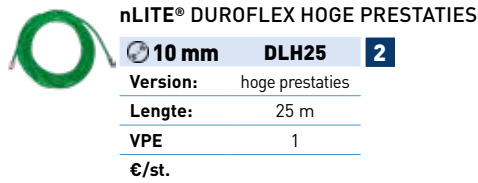
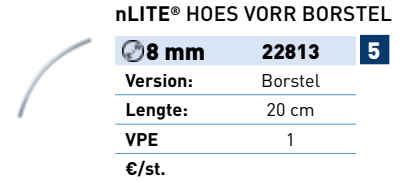
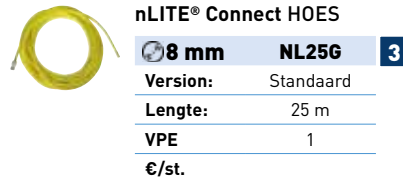
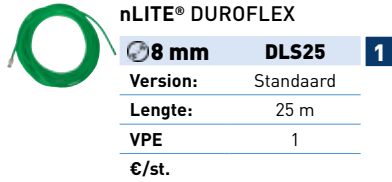

⊘ = Binnendiameter

### SNELKOPPELING

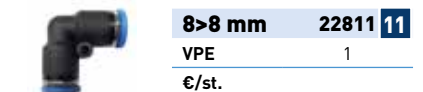
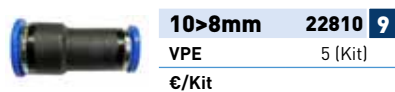
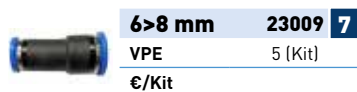
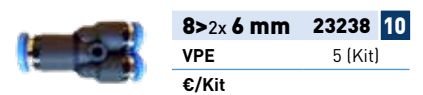
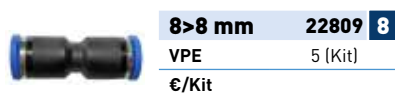
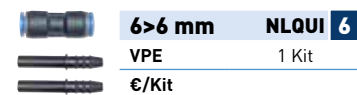

### CONNECTOREN VOOR HOES

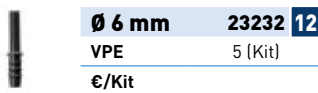

### WATERSTROOM ADAPTER

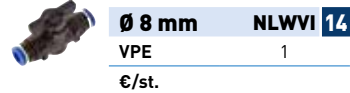

### FILTERAANSLUITING

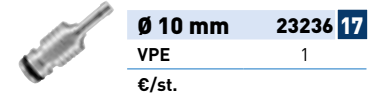
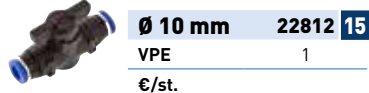
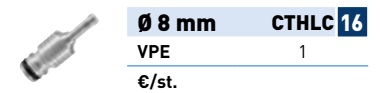

### AANSLUITVOORBEEDEN

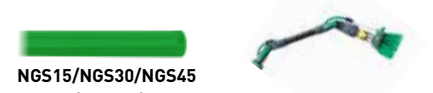



# WATERGELEIDENDE STELEN

## nLite® CONNECT



ZOLANG DE VOORRAAD STREKT



### nLite® Connect ULTRA HIMOD BASISELEMENT (UH67G)

Art. Nr.	Ø mm	Segment	Klem	VPE	€/stuk
18608	26	1	●	1	
18610	29	2	●	1	
18611	32	3	●	1	
18612	35	4	●+●	1	

### nLite® Connect ULTRA HIMOD UITBREIDINGSELEMENT (UH35G)

Art. Nr.	Ø mm	Segment	Klem	VPE	€/stuk
18613	32	1	-	1	
18614	35	2	●+●	1	

### nLite® Connect HIMOD BASISELEMENT (UC67G)

Art. Nr.	Ø mm	Segment	Klem	VPE	€/stuk
17254	26	1	●	1	
17260	29	2	●	1	
17266	32	3	●	1	
17272	35	4	●+●	1	

### nLite® Connect HIMOD UITBREIDINGSELEMENT (UC35G)

Art. Nr.	Ø mm	Segment	Klem	VPE	€/stuk
17279	32	1	-	1	
17396	35	2	●+●	1	

### nLite® Connect CARBON BASISELEMENT (CT67G)

Art. Nr.	Ø mm	Segment	Klem	VPE	€/stuk
17253	26	1	●	1	
17259	29	2	●	1	
17265	32	3	●	1	
17271	35	4	●+●	1	

### nLite® Connect CARBON UITBREIDINGSELEMENT (CT35G)

Art. Nr.	Ø mm	Segment	Klem	VPE	€/stuk
17278	32	1	-	1	
17394	35	2	●+●	1	

\*Indien een steelement niet meer beschikbaar is in de kwaliteiten glasvezel of hybride, zal het ter vervanging in carbon worden geleverd tegen dezelfde prijs.



### nLite® Connect MASTERELEMENT ALUMINIUM (AN45G / AN60G)

Art. Nr.	Ø mm	Segment	Klem	VPE	€/stuk
17828	26	1 (4,50 m)	●	1	
17829	29	2 (4,50 m)	●	1	
17830	32	3 (4,50 m)	●	1	
17831	35	4 (4,50 m)	●+●	1	
17824	26	1 (6,00 m)	●	1	
17825	29	2 (6,00 m)	●	1	
17826	32	3 (6,00 m)	●	1	
17827	35	4 (6,00 m)	●+●	1	



### nLite® Connect UITBREIDINGSELEMENT ALUMINIUM (AN30G)

Art. Nr.	Ø mm	Segment	Klem	VPE	€/stuk
17832	32	1 (3,00 m)	-	1	
17833	35	2 (3,00 m)	●+●	1	

### nLite® Connect KLEMMEN

Elem. 1 - Ø 26mm		Elem. 2 - Ø 29mm		Elem. 3 - Ø 32mm		Elem. 4 - Ø 35mm		VPE
Art. Nr.	€/stuk	Art. Nr.	€/stuk	Art. Nr.	€/stuk	Art. Nr.	€/stuk	
23227	●	23228	●	23229	●	23231	●	1
23233	●	(ohne Schlauch-Clip)		23230	●			1

geel hendel

grijs hendel

23231 = nLite Connect element 4 bovenste steeleinde  
23230 = nLite Connect basis & uitbreiding lagere steeleinde

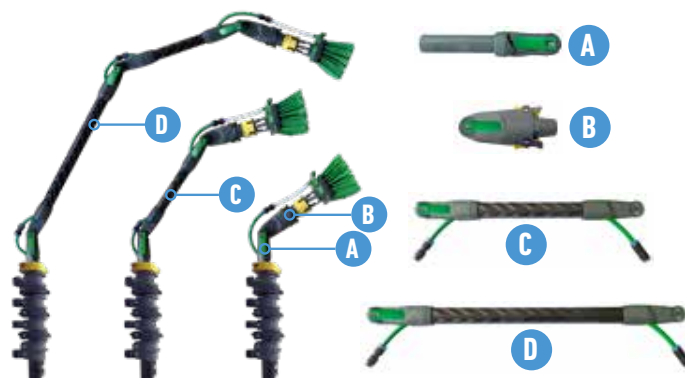

### nLite® Connect HOEKADAPTER ELEMENTE

Art. Nr.	Info	VPE	€/stuk
NGC00	Element A - steeladapter	1	
22806	Element B - borsteladapter	1	
22807	Element C - kort (incl. slang & snelkoppeling)	1	
22808	Element D - lang (incl. slang & snelkoppeling)	1	

### nLite® MULTILINK HOEKADAPTERS

Art. Nr.	Afmeting	Gewicht	Materiaal	VPE	€/stuk
FTGOS	15 cm	50 g	Kunststof	1	



# WATERGELEIDENDE STELEN

## nLite® ONE, nLite® CONNECT

ZOLANG DE VOORRAAD STREKT

### nLite® Connect EINDSTUK



#### Kunststof beschermkap met rubber

- Voorkomt beschadiging van het steeleinde
- Zijdelingse opening voor de slang
- Eenvoudig in te steken in de steel en met klem te bevestigen.

Art. Nr.	VPE	€/stuk
TMECP	1	



### nLite® Connect SPROEIJERS

#### Snelsluitingssproeiers voor nLite® borstels

- NLBJF: Voor het opsproeien van water, genereert een constante waterfilm
- NLBJP: Voor het spoelen en verwijderen van vuil met druk
- Let op: Hoe meer sproeiers er gebruikt worden, des te geringer wordt de waterdruk

Art. Nr.	Info	VPE	€/kit
NLBJF	1 Set = 2 sproeiers	1 kit	
NLBJP	1 Set = 2 sproeiers	1 kit	



### nLite® Connect SLANGCLIPS

Art. Nr.	VPE	€/stuk
17149	10	



### nLite® Connect GEREEDSCHAP ADAPTER

- Kunststof adapter voor het bevestigen van hulpmiddelen om de nLite® slang
- FTTHR: Levert schroefdraad voor het vastschroeven van een borstel
- HFNLC: Conus adapter voor klassiek reinigingsgereedschap.

Art. Nr.	VPE	€/stuk
FTTHR	1	
HFNLC	1	

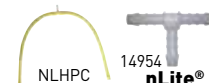

### nLite® Connect BORSTEL AANSLUITINGSKIT 5MM

- Verbindt twee sproeiers met de borstel en zorgt voor de aansluiting met de waterslang
- NLHPC: 2 slangstukken Ø 5mm + 1 T-stuk 14954
- 14954: T-stuk - verbindt van slangstukken.

Art. Nr.	Info	VPE	€/stuk
NLHPC	Aansluitingskit 5mm	1	
14954	T-stuk 5mm	1	



### nLite® Connect BORSTEL AANSLUITINGSKIT 8MM

- Verbindt twee sproeiers met de borstel en zorgt voor de aansluiting met de waterslang
- NLHPA: 2 slangstukken Ø 8mm + 1 T-stuk 20478
- 20477: Stekkernippel voor aansluiting van 8 mm slang met T-stuk 20478
- 20478: T-stuk - verbindt van slangstukken.

Art. Nr.	Info	VPE	€/kit
NLHPA	Aansluitingskit 8mm	1	
23232	Stopnippel 6mm	5 (kit)	
23237	Stopnippel 8mm	5 (kit)	
23238	T-stuk 8mm	5 (kit)	



### SLANGENSETS

- 1x male-adapter voor slangwagen
- 1x female-adapter voor steel

Art. Nr.	Maat	Ø binnen	VPE	€/stuk
PH10Y	100 m	5mm	1	



### Universele klittenbanden voor ø van 20-70 mm

TMOOT

TMOON

Speciale nLite®-klem voor een ø van 35 mm

### nLite® Connect BORSTELSOKKEL

- Reservesokkel om borstel en hoekadapter te verbinden.
- Kan omgedraaid worden, om de hoek van de borstel en de indeling van de sproeiers te veranderen.

Art. Nr.	VPE	€/stuk
NLBRS	1	

### HiFlo Control

#### Waterstroom altijd regelbaar

- past op alle stelen met een ø van 20-70 mm
- voor slangen met een buitendiameter van 8 of 9 mm

Art. Nr.	Info	VPE	€/stuk
TMOON	Klemmen, die op iedere nLite® Connect-steel passen	1	
TMOOT	Klittenbanden, die op universele stelen passen	1	

# KLASSIEKE GLASREINIGING

## TELESCOOPSTELEN & WISSERS

### OPTI LOC



#### OptiLoc 3-DELIG, BUITENSTEEL Ø29MM

Art. Nr.	Maat	Voor	VPE	€/stuk
AP125	1,00 m	ED370	1	
AP150	1,50 m	ED450	1	
AP200	2,00 m	ED600	1	



#### OptiLoc 3-DELIG, MIDDENSTEEL Ø25MM

Art. Nr.	Maat	Voor	VPE	€/stuk
MR125	1,25 m	ED370	1	
MR150	1,50 m	ED450	1	
MR200	2,00 m	ED600	1	



#### OptiLoc & TelePlus BIN STEEL Ø21MM

Art. Nr.	Maat	Voor	VPE	€/stuk
IR060	0,60 m	EZ120, ED180	1	
IR110	1,00 m	ED370	1	
IR125	1,25 m	EZ250, ED370, TZ250, TD370, TV500, TF620	1	
IR150	1,50 m	EZ300, ED450, TD370	1	
IR200	2,00 m	EZ400, ED600, TZ400, TD600, TV800, TF100	1	
14887	2,50 m	EZ500, ED750	1	
IR300	3,00 m	EZ600, ED900	1	

#### OptiLoc GREEP

Art. Nr.	Maat	Voor	VPE	€/stuk
GR250	25 mm	OptiLoc EZ...	5	
GR300	29 mm	OptiLoc ED...	5	



#### OptiLoc SLUITING

Art. Nr.	Maat	Voor	VPE	€/stuk
VS250	25 mm	OptiLoc EZ + ED Sect.2	5	
VS300	29 mm	OptiLoc ED Section 3	5	



### ERGOTEC® NINJA

#### ErgoTec® NINJA CLIPS

Art. Nr.	VPE	€/stuk
PPLUG	5 Sets	



### TELE PLUS



#### TelePlus SCHROEFDRAADKLEM

Art. Nr.	Maat	Voor	VPE	€/stuk
GKL25	25 mm	TelePlus basis	10	



#### TelePlus SCHROEFDRAADPLAATJE

Art. Nr.	Maat	Voor	VPE	€/stuk
GKL29	29 mm	TelePlus 3+4+5	10	



#### TelePlus SLUITING

Art. Nr.	Maat	Voor	VPE	€/stuk
YE250	25 mm	Sect. 2	5	
YE290	29 mm	Plus 3	5	
YE330	33 mm	Plus 4	5	
YE370	37 mm	Plus 5	5	



#### TelePlus GREEP

Art. Nr.	Maat	Voor	VPE	€/stuk
TPG37	37 mm	Plus 5	5	



### BUCKET ON A BELT

#### Bucket On A Belt PROTECTOR

Art. Nr.	Info	VPE	€/stuk
BBPRO	voor BB010	1	



### EMMER 18 L

#### ONDERDEL VOOR INWASSERS

Art. Nr.	Info	VPE	€/stuk
11113	voor QB120	1	



#### ONDERDEL VOOR WISSERS

Art. Nr.	Info	VPE	€/stuk
13874	voor QB120	1	



### VISA VERSA

#### VisaVersa® GRIP

Art. Nr.	Info	VPE	€/stuk
VH000	voor VPxxx	1	



#### VisaVersa® KOP

Art. Nr.	Info	VPE	€/stuk
VS000	voor VPxxx	1	



# KLASSIEKE GLASREINIGING SCHRAPER

## ERGO TEC® NINJA



### ErgoTec®NINJA BESCHERMKAP

Art. Nr.	Info	VPE	€/stuk
18103	10cm voor EN100	1	
18085	15cm voor EN150	1	



### ErgoTec®NINJA SLEUVEN

Art. Nr.	Info	VPE	€/stuk
18108	10cm, voor EN100	1	
18098	15cm, voor EN150	1	

## ERGO TEC®



### ErgoTec® Glasschraper BESCHERMKAP

Art. Nr.	Info	VPE	€/stuk
EGC10	10cm voor EG100	1	
EGC15	15cm voor EG150	1	



### ErgoTec® Glasschraper SLEUVEN

Art. Nr.	Info	VPE	€/stuk
EGH10	10cm, voor EG100	1	
EGH15	15cm, voor EG150	1	

## OPPERVLAKTESCHRAPERS



### ErgoTec® Schraper BESCHERMKAP

Art. Nr.	Info	VPE	€/stuk
15767	10cm, voor SH000, SH250, LH120	10	

## TRIM



### Trim PLASTIC DOOS, VOOR MESSEN

Art. Nr.	Info	VPE	€/stuk
PLET0	voor TM100, TR100	10	

# RAAM BINNENREINIGING STINGRAY® OS

**STINGRAY**   
*The Ultimate Indoor Cleaning Tool*



## Stingray OS BASIS HANDAPPARAAT

Art. Nr.	Inhoud	VPE	€/stuk
SROHH	incl. opvulbare fles en 2x alkalische AA baerij	1	



## Stingray OS OPVULBARE FLES

Art. Nr.	Grootte	VPE	€/stuk
SRBT1	150 ml	1	





# ONDERHOUDSREINIGING

## erGO!, DUBBELE ROLEMMER & BEZEM



Quality Tools for Smart Cleaning

### erGO! clean & wax

## erGO!



#### erGO! DISPENSER SLANG

Voor erGO! klap-straaleenheid FAVAS

Art. Nr.	VPE	€/stuk
FADTS	1 kit (5 st.)	

### HOLD UP



#### HOLD UP RESERVERUBBER

HU450, HU900

Art. Nr.	VPE	€/stuk
EG450	10	

#### erGO! KLITTENBAND VERVANG-STRIPS

Voor erGO! klittenband mop FAVMH

Art. Nr.	VPE	€/stuk
FAVMK	1 kit (2 st.)	

### SMART COLOR DUBBELE ROLEMMER



#### SmartColor KUNSTSTOF PERS

Art. Nr.	kleur	VPE	€/stuk
SPREG	●	1	

#### erGO! KLAP-STRAALEENHEIDT

Voor erGO! stelen FAEPL en FASPL

Art. Nr.	VPE	€/stuk
FAVAS	1	

#### SmartColor RESERVEWIELEN

Art. Nr.	Inhoud	VPE	€/stuk
17891	4 stuks	1 kit	

### ERGO SCHOP



#### ErgoSchop VERVANGING BEZEM

Art. Nr.	VPE	€/stuk
15494	1	



Quality Tools for Smart Cleaning

# WANNEER JE INFORMATIE NODIG HEBT - JE VINDT ONS OVERAL

Ontdek alle wetenswaardigheden over de **UNGER** producten en de nieuwste reinigingstechnologieën op onze homepage [ungerglobal.com](http://ungerglobal.com) en onze social media kanalen:



BEUR



Geldig vanaf 1-1-2024. Voor de bestellingen van onze zakelijke handelsklanten en onze leveringen zijn uitsluitend de algemene leverings- en betalingsvoorwaarden van de **UNGER** Germany GmbH in de meest recente versie van toepassing, te bekijken op [www.ungerglobal.com](http://www.ungerglobal.com). Alle prijzen zijn vrijblijvend aanbevolen detailhandelsprijzen exclusief btw. Alle informatie onder voorbehoud, wijzigingen voorbehouden.

**UNGER Germany GmbH**

Piepersberg 44  
D-42653 Solingen  
GERMANY  
Tel.: (49) 0212 2207 260  
Fax: (49) 0212 2207 222  
[ungereurope@ungerglobal.com](mailto:ungereurope@ungerglobal.com)

**UNGER Enterprises LLC**

425 Asylum Street  
Bridgeport, CT 06610  
USA  
Tel.: (1) 800 431 2324  
Fax: (1) 800 367 1988  
[unger@ungerglobal.com](mailto:unger@ungerglobal.com)

**UNGER UK Ltd.**

F1 Deansgate, 62-70 Tettenhall Road  
Wolverhampton, WV1 4TH  
UNITED KINGDOM  
Tel.: (44) 01902 306633  
Fax: (44) 01902 306644  
[ungeluk@ungerglobal.com](mailto:ungeluk@ungerglobal.com)



[www.ungerglobal.com](http://www.ungerglobal.com)